

# HSF RoHS

## SPECIFICATIONS

Signal Rated Current:2.5AMP  
 Power Rated Current:30AMP  
 Signal Rated Voltage:50V AC  
 Power Rated Voltage:250V AC  
 Signal Contact Resistance:20mΩ Max  
 Power Contact Resistance:2mΩ Max  
 Signal Contact Withstand Voltage:1000V AC For 1 Minute  
 Power Contact Withstand Voltage:2500V AC For 1 Minute  
 Insulation Resistance:1000MΩ Min  
 Operation Temperature:-40°C to +105°C

Power Contact Material:Copper Alloy  
 Signal Contact Material:Copper Alloy  
 Contact Plating:Au or Sn Over Ni  
 PEG Material:Copper Alloy  
 PEG Plating:Tin Over Ni  
 Insulator Material:PA6T(UL94V-0)  
 Max.Processing Temp: 260°C±5°C For 5~10 Second

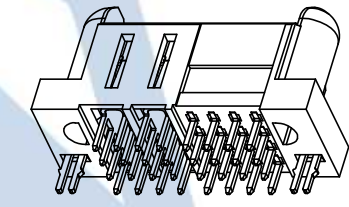
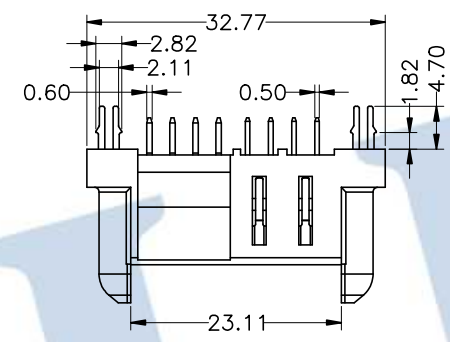
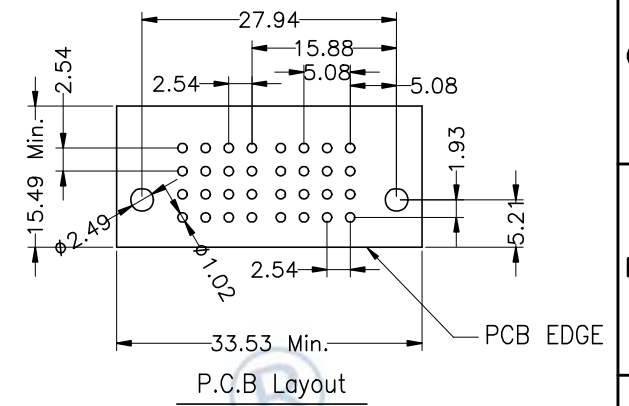
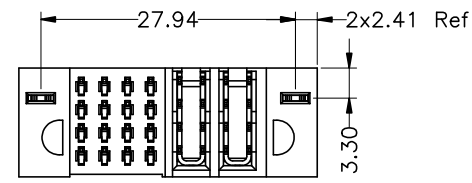

## Ordering Information

**4500 - 18 F XX C S X XX**

No. of Pins: 16 Single, +2 Power  
 Contact Type: M: Male, F: Female  
 Contact Plating: S1: 3u" Gold/Matte-Tin, S2: 5u" Gold/Matte-Tin  
 Insulator Material Option: C=BK-PA6T  
 Packing: A: Tray  
 Code Stream

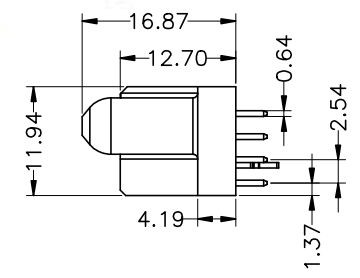
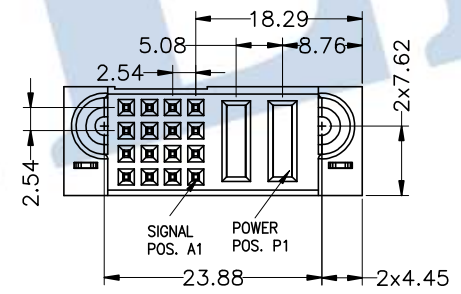
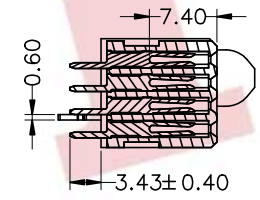

				OPERATION		DRAW	YiYuSheng	18.08.26	SCALE	FIT	<b>JILN</b> ® 深圳市锦凌电子有限公司 SHENZHEN JINLING ELECTRONICS CO.,LTD Tel: 86-755-27483253 Fax: 86-755-2997-5588	
				X.X	±0.30				UNIT	mm		
				X.XX	±0.20	CHECK		SIZE	A4	PART NO. 4500-18FXXCSXXX		
				X.XXX	±0.10		SHEET	1/1				
A0	2018.08.26	NEW DRAWING		Angle	±3°	APPROVE		PROJ.	◆	TITLE:	HCP 16S+2P 电源座 直母	
REV	DATE	MODIFICATION DESCRIPTION		DIM	TOL							